

FLAT PANEL SINGLE ARM ARTICULATING MOUNT (Universal)

SPECIFICATIONS

- Compatibility : 37" to 50" Flat Panel
 Maximum load : 56.7 KG (125 lbs)
 VESA : 100x100, 200x100, 200x200, 400x200, 600x400
 Mounting Profile : 100mm (3.94") from Wall
 Tilting Angle : -5 to + 20 degree
 Color : Black
 Qty / Carton : 1 pcs

KEY FEATURES

- Extended up to 390mm (15.354")
- Great flexibility and adaptability
- Pre-assembled for ease of installation
- VESA compliance
- Installation hardware included
- Integrated cable management system
- Designed to be mounted on concrete or masonry wall

DRAWINGS & DIMENSIONS

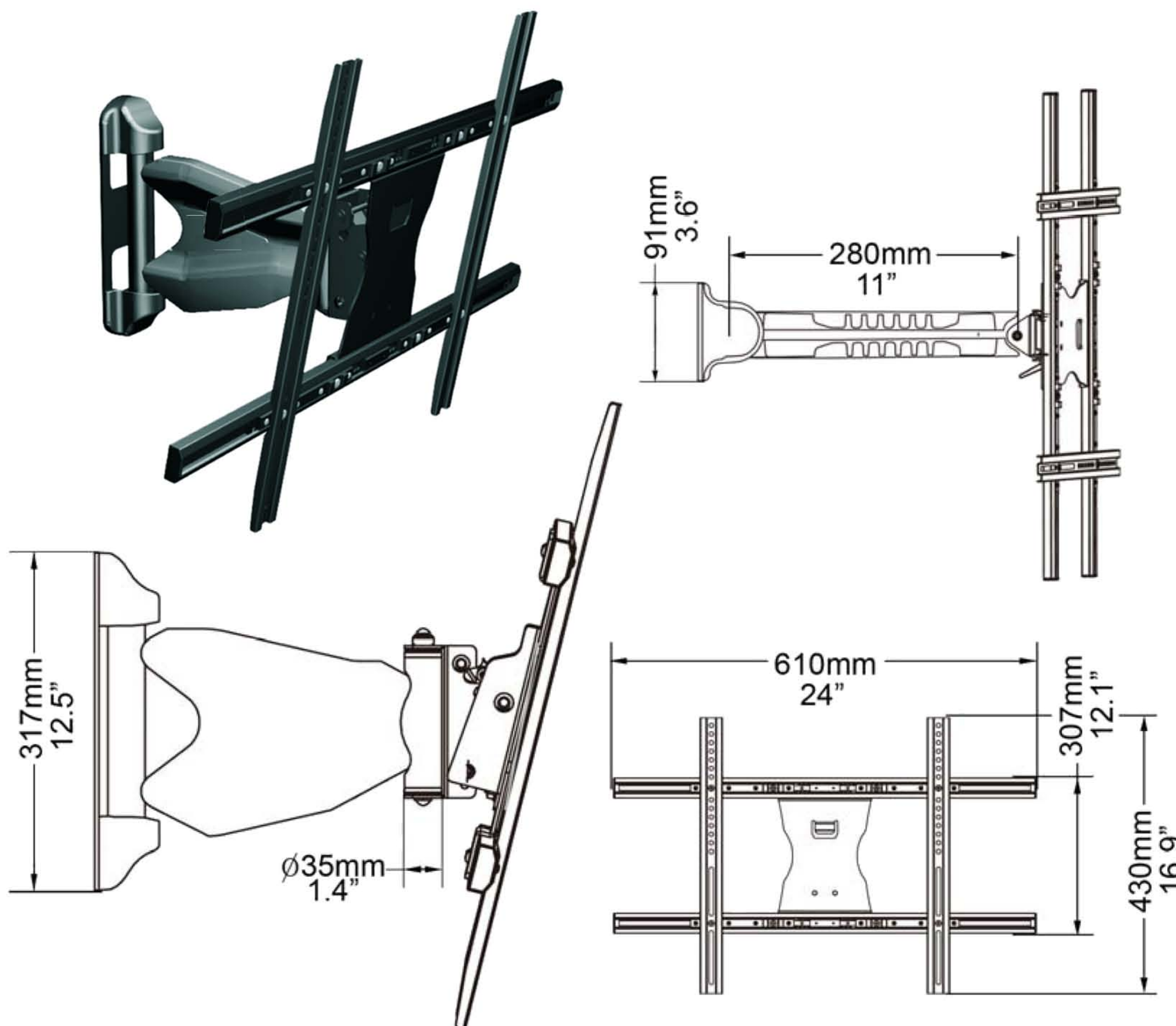







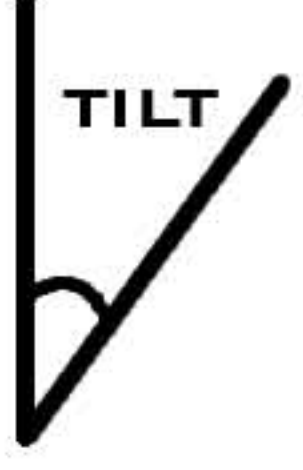

OPT-CL63-L

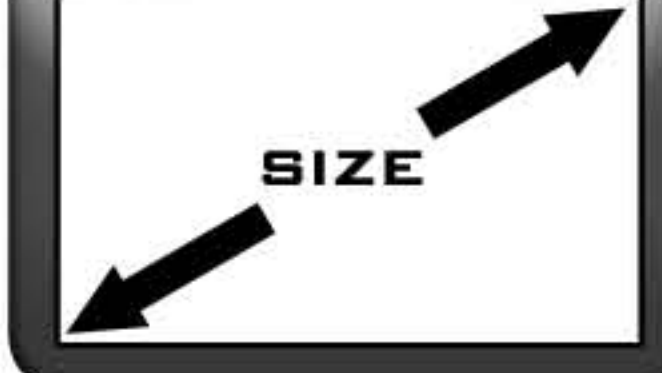

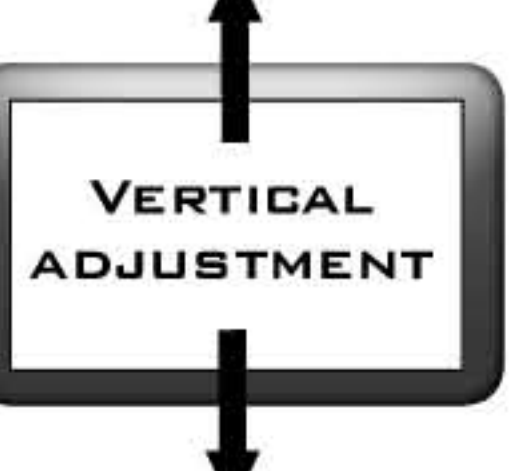
(OPT-CL63-L)

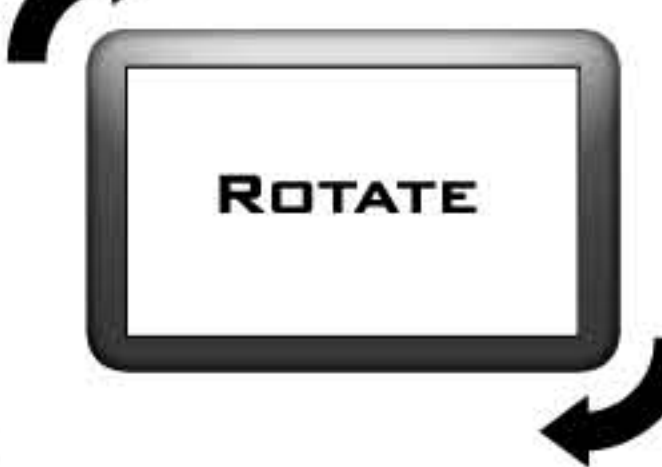
SPECIFICATIONS

	
56.7KG (125 LBS)	-5 TO +20 DEGREE
	
180 DEGREE	37" TO 50"
	
90MM TO 390MM	N.A
	
N.A	N.A
VESA STANDARD 75 x 75 100 x 100 200 x 100 200 x 200 400 x 200 600 x 400 800 x 400	 COLOR
HIGH-LIGHTED	BLACK / SILVER
	CABLE MANAGEMENT
INCLUDED	AVAILABLE

For General Information & Sales Enquires

OPTVIO PTE LTD

Block 20, Woodlands Link #08 - 11
Woodlands East Industrial Estate
Singapore 738733

Website: www.optvio.com
Tel : (65) 62572029
Fax : (65) 62575829



PRODUCT OF SINGAPORE