

# FLAT PANEL SINGLE ARM ARTICULATING MOUNT (VESA)

## SPECIFICATIONS

- Compatibility : 14" to 22" Flat Panel
- Maximum load : 25 KG (55 lbs)
- VESA : 75mm X 75mm OR 100mm X 100mm
- Mounting Profile : 40mm (1.57") from Wall
- Tilting Angle : -20 to +20 degree
- Color : Silver
- Qty / Carton : 12 pcs

## KEY FEATURES

- Great flexibility and adaptability
- Pre-assembled for ease of installation
- Designed to be mounted on concrete or masonry wall
- VESA compliance
- Hardware included
- Space Saving
- Easy Installation
- Can also be used as Wall Speaker Mount

## DRAWINGS & DIMENSIONS

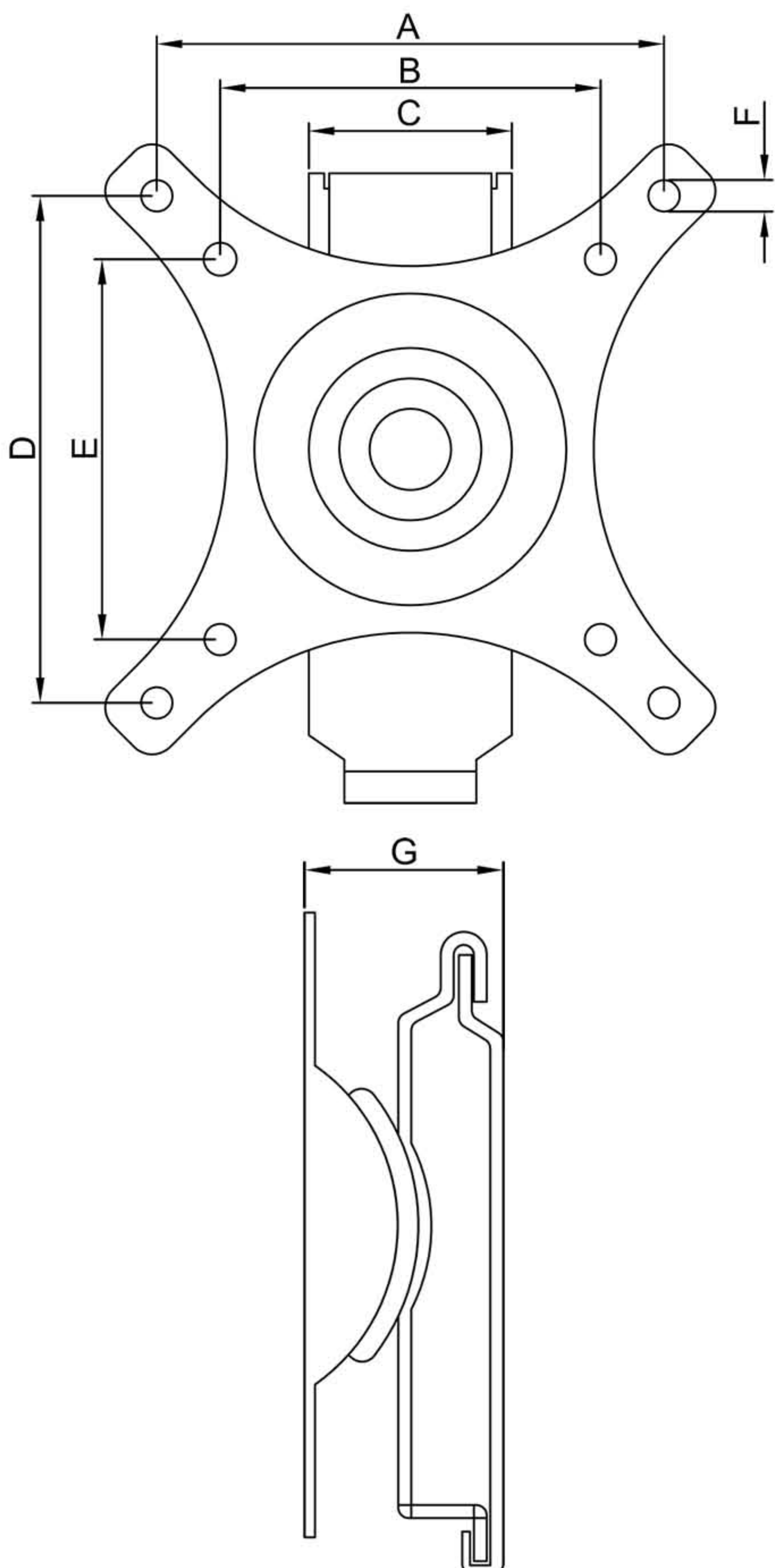

## DIMENSIONS







A	3.94"	100 mm
B	2.95"	75 mm
C	2.17"	55 mm
D	3.94"	100 mm
E	2.95"	75 mm
F	0.244"	6.2 mm
G	1.57"	40 mm

OPT-WM-10

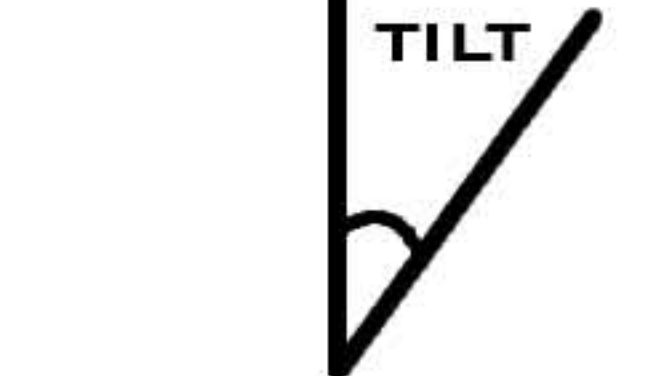
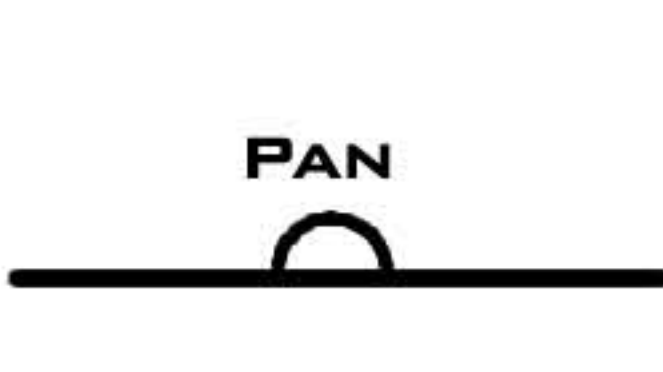
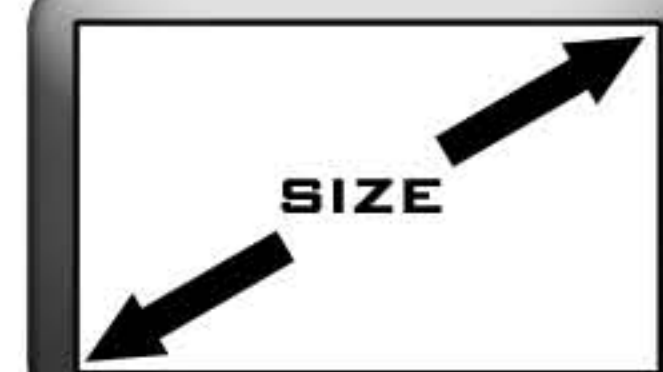

(OPT-WM-10)

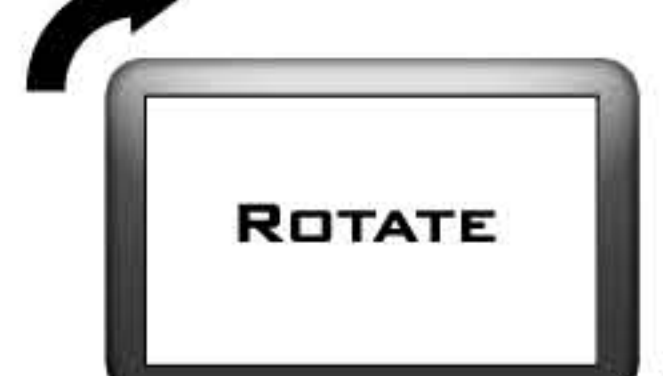
## SPECIFICATIONS

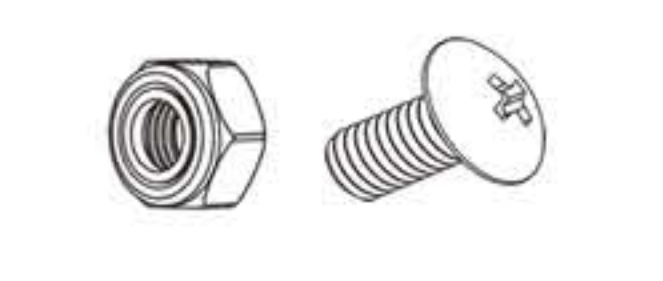
 <b>LOAD</b>	 <b>TILT</b>
25KG (55LBS)	-20 TO +20 DEGREE
 <b>PAN</b>	 <b>SIZE</b>
N.A	14" TO 24"
 <b>DISTANCE FROM WALL</b>	 <b>VERTICAL ADJUSTMENT</b>
45MM(1.57")	N.A
 <b>HORIZONTAL ADJUSTMENT</b>	 <b>ROTATE</b>
N.A	360 DEGREE
<b>VESA STANDARD</b> 75 x 75 100 x 100 200 x 100 200 x 200 400 x 200 600 x 400 800 x 400	 <b>COLOR</b>
HIGH-LIGHTED	BLACK / SILVER
 <b>HARDWARE</b>	<b>CABLE MANAGEMENT</b>
INCLUDED	N.A

For General Information & Sales Enquires

OPTVIO PTE LTD

Block 20, Woodlands Link #08 - 11  
Woodlands East Industrial Estate  
Singapore 738733

Website: [www.optvio.com](http://www.optvio.com)  
Tel : (65) 62572029  
Fax : (65) 62575829



PRODUCT OF SINGAPORE