

FLAT PANEL MOBILE STAND (OPT-MS-110)

SPECIFICATIONS

Compatibility	: 32" to 55" Flat Panel
Weight Capacity	: 23 KG (50.6 lbs) -33KG (72.6 lbs)
Color	: Black
Tilting Angle	: 0 to +20 degree

KEY FEATURES





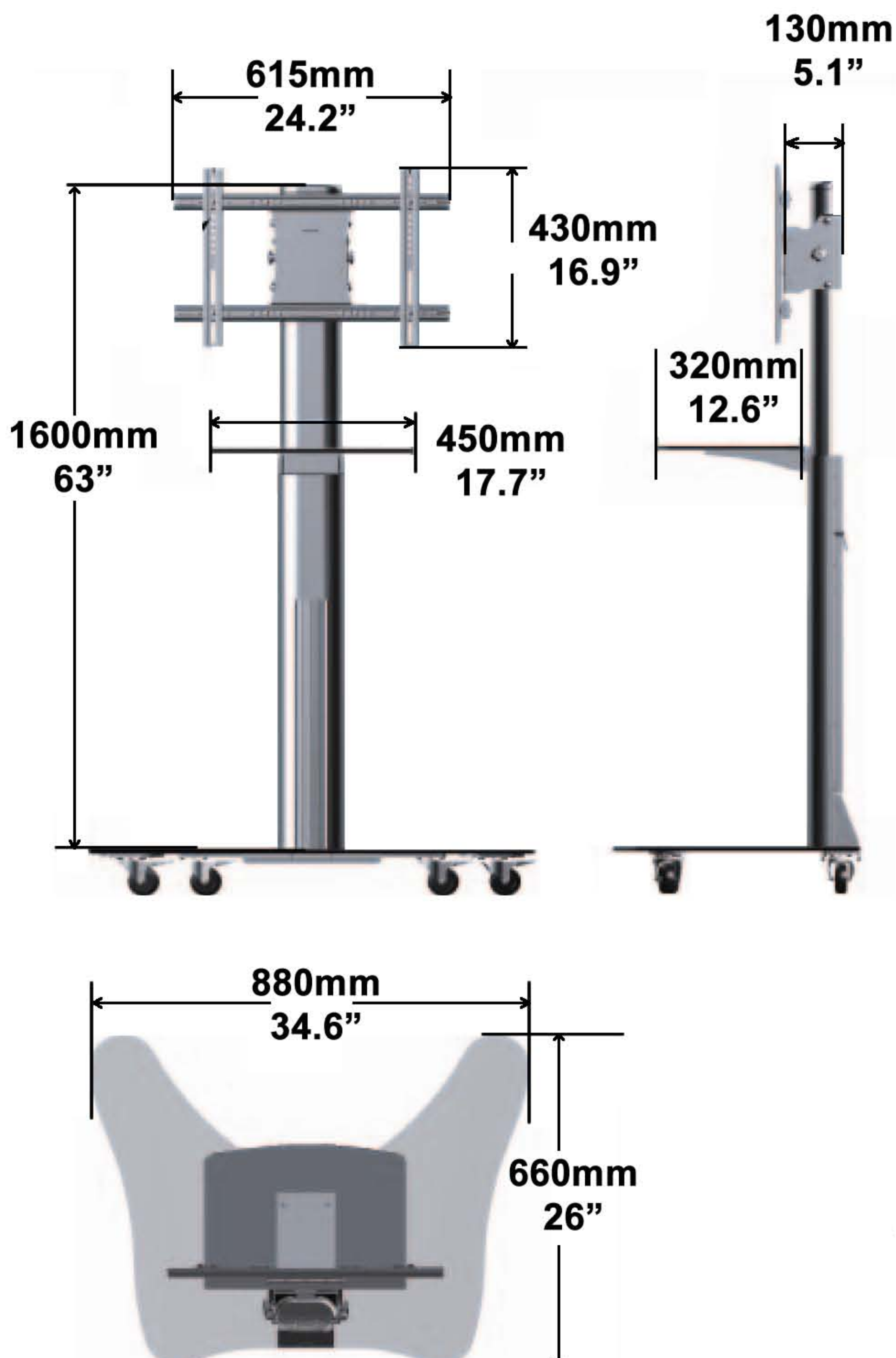

- Spring loaded mechanism for height adjustment
- "SCM" Self Centering Mount (TV always at the center of the stand)
- Aluminium Extrusion Pole
- Great Mobility, flexibility and adaptability
- Adjustable Shelf for DVD player
- Fast disconnection for ease of maintenance
- Hardware included
- Integrated Cable Management

DRAWINGS & DIMENSIONS

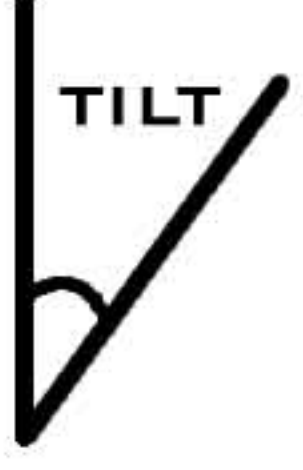

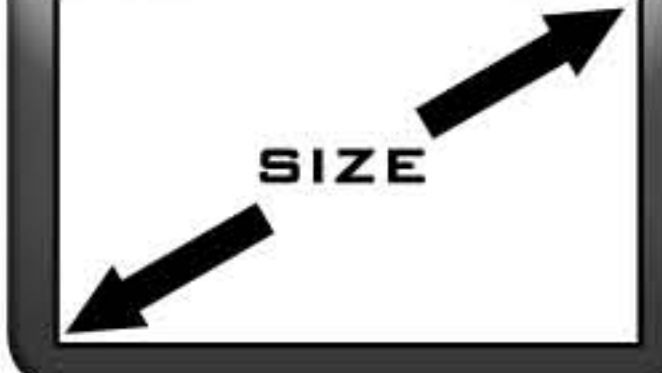
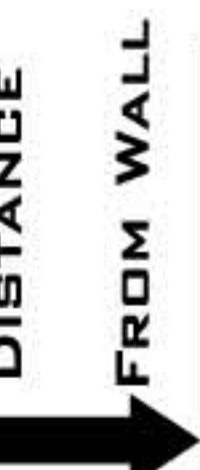
(OPT-MS-110)

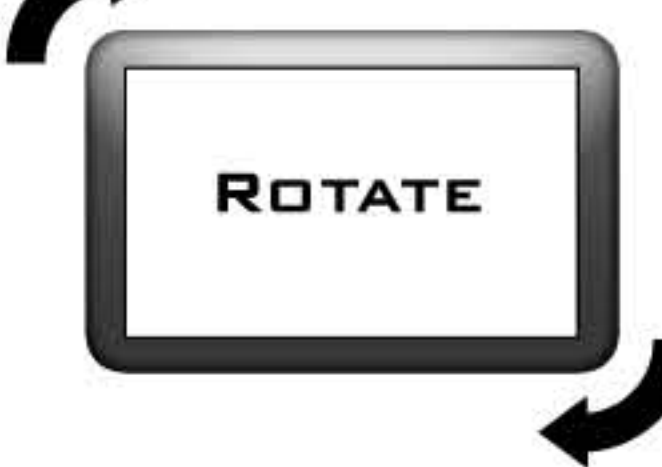
SPECIFICATIONS

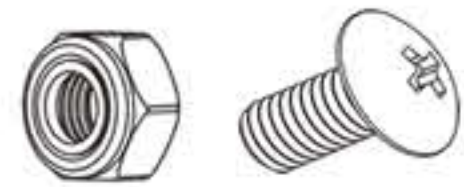
 LOAD	 TILT
100KG (220LBS)	0 TO +20 DEGREE
 PAN	 SIZE
N.A	32" TO 50"
 DISTANCE FROM WALL	 VERTICAL ADJUSTMENT
N.A	ENTIRE POLE
 HORIZONTAL ADJUSTMENT	 ROTATE
AVAILABLE	N.A
VESA STANDARD 75 x 75 100 x 100 200 x 100 200 x 200 400 x 200 600 x 400 800 x 400	 COLOR
HIGH-LIGHTED	BLACK / SILVER
 HARDWARE	CABLE MANAGEMENT
INCLUDED	AVAILABLE

For General Information & Sales Enquires

OPTVIO PTE LTD

Block 20, Woodlands Link #08 - 11
Woodlands East Industrial Estate
Singapore 738733

Website: www.optvio.com
Tel : (65) 62572029
Fax : (65) 62575829



PRODUCT OF SINGAPORE