

FLAT PANEL SINGLE ARM ARTICULATING MOUNT (VESA)

SPECIFICATIONS

- Compatibility : 14" to 22" Flat Panel
- Maximum load : 25 KG (55 lbs)
- VESA : 75mm X 75mm OR 100mm X 100mm
- Mounting Profile : 40mm (1.57") from Wall
- Tilting Angle : -20 to +20 degree
- Color : Silver
- Qty / Carton : 12 pcs

KEY FEATURES

- Great flexibility and adaptability
- Pre-assembled for ease of installation
- Designed to be mounted on concrete or masonry wall
- VESA compliance
- Hardware included
- Space Saving
- Easy Installation
- Can also be used as Wall Speaker Mount

DRAWINGS & DIMENSIONS

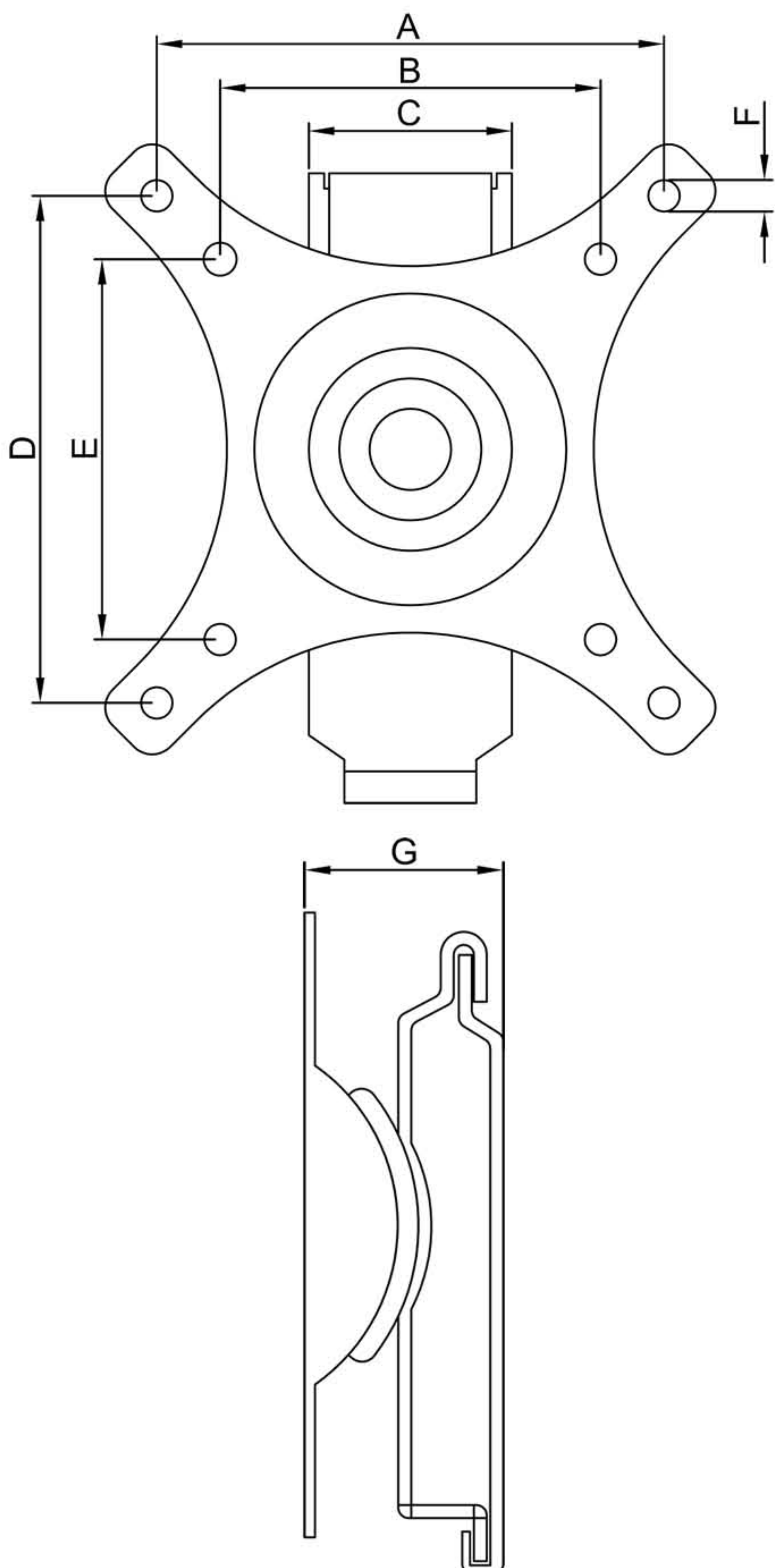

DIMENSIONS







A	3.94"	100 mm
B	2.95"	75 mm
C	2.17"	55 mm
D	3.94"	100 mm
E	2.95"	75 mm
F	0.244"	6.2 mm
G	1.57"	40 mm

OPT-WM-10

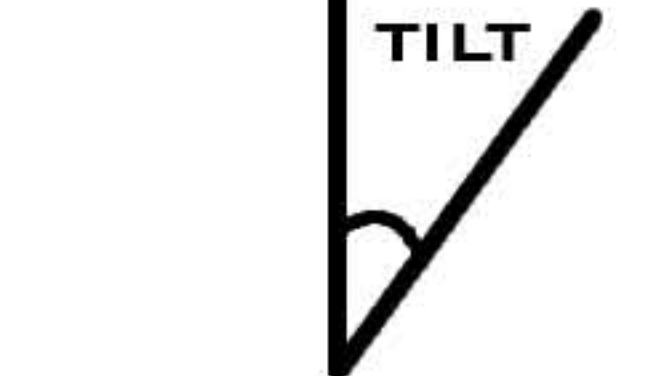
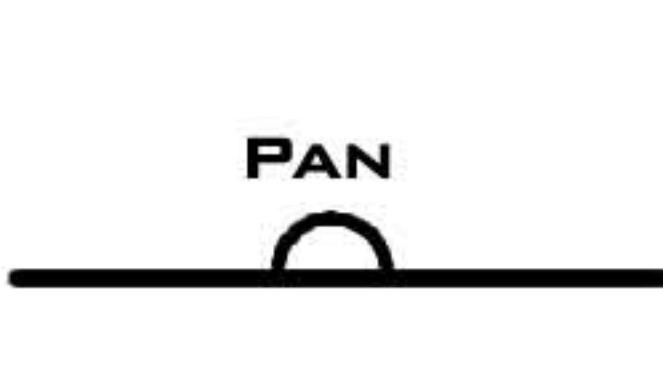
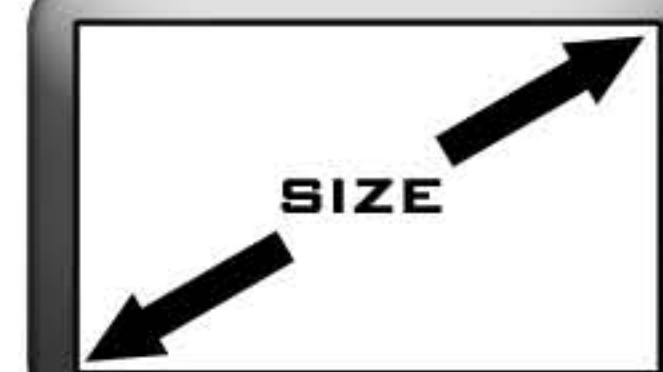

(OPT-WM-10)

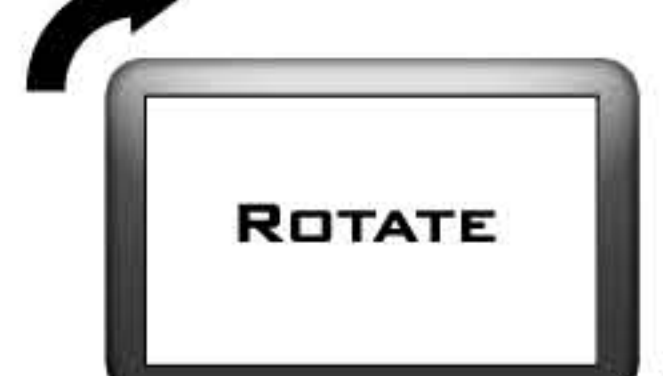
SPECIFICATIONS

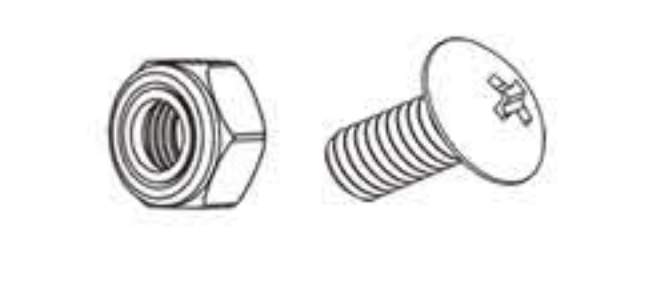
 LOAD	 TILT
25KG (55LBS)	-20 TO +20 DEGREE
 PAN	 SIZE
N.A	14" TO 24"
 DISTANCE FROM WALL	 VERTICAL ADJUSTMENT
45MM(1.57")	N.A
 HORIZONTAL ADJUSTMENT	 ROTATE
N.A	360 DEGREE
VESA STANDARD 75 x 75 100 x 100 200 x 100 200 x 200 400 x 200 600 x 400 800 x 400	 COLOR
HIGH-LIGHTED	BLACK / SILVER
 HARDWARE	CABLE MANAGEMENT
INCLUDED	N.A

For General Information & Sales Enquires

OPTVIO PTE LTD

Block 20, Woodlands Link #08 - 11
Woodlands East Industrial Estate
Singapore 738733

Website: www.optvio.com
Tel : (65) 62572029
Fax : (65) 62575829



PRODUCT OF SINGAPORE