

# FLAT PANEL TILT MOUNT MEDIUM (OPT-WM-25T)

## SPECIFICATIONS

- Compatibility : 26" to 42" Flat Panel
- Maximum load : 50 KG (110 lbs)
- Mounting Profile : 64mm (2.52") from wall
- Tilting Angle : -9 to +15 degree
- Color : Black
- Qty / Carton : 4 pcs



## KEY FEATURES

- Tilting Range from -9 to +15 degree
- Slim Tilt Mount with only 64mm (2.52") between screen and wall
- Great flexibility and adaptability
- Pre-assembled for ease of installation
- Designed to be mounted on concrete or masonry wall
- VESA compliance
- Hardware included
- Comes with Bubble leveler

## DRAWINGS & DIMENSIONS

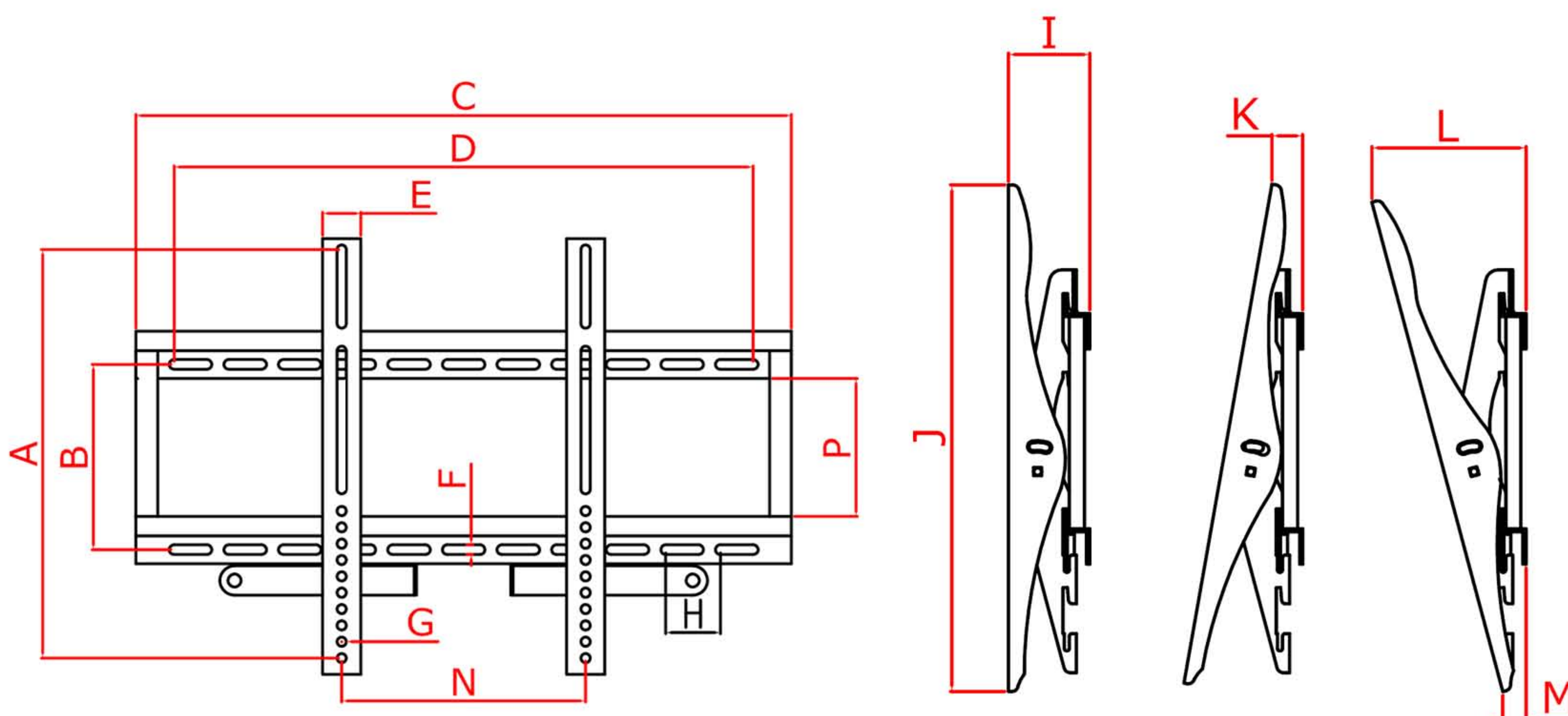





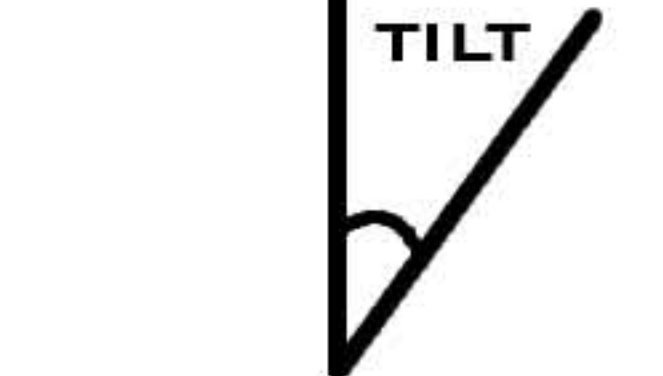
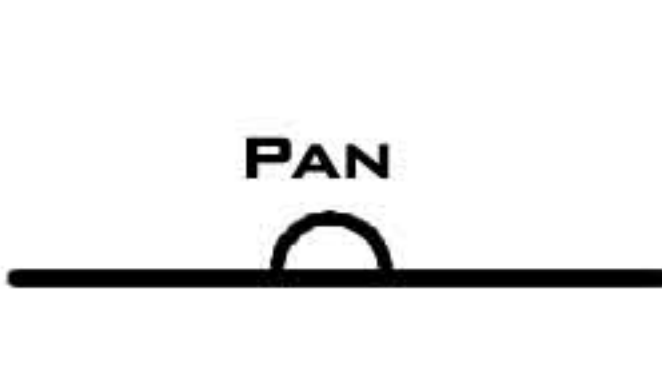
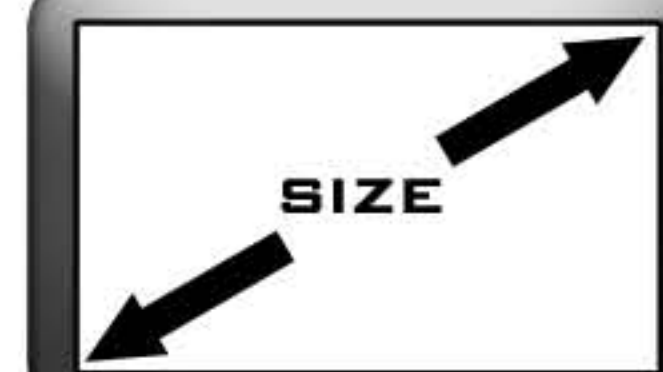

Dimensions

A	14.76"	375mm	I	2.52"	64mm
B	6.69"	170mm	J	15.75"	400mm
C	23.62"	600mm	K	0.96"	24.4mm
D	20.87"	530mm	L	4.80"	121.8mm
E	1.38"	35mm	M	0.72"	18.3mm
F	0.35"	9mm	N	2.95-20.66"	75-525mm
G	0.33"	8.5mm	P	4.98"	126.5mm
H	1.97"	50mm			

## (OPT-WM-25T)

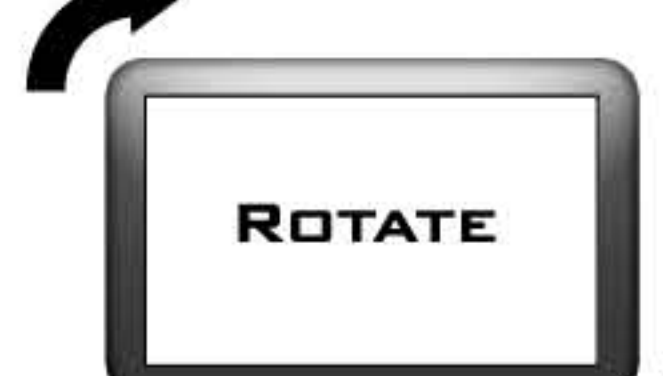
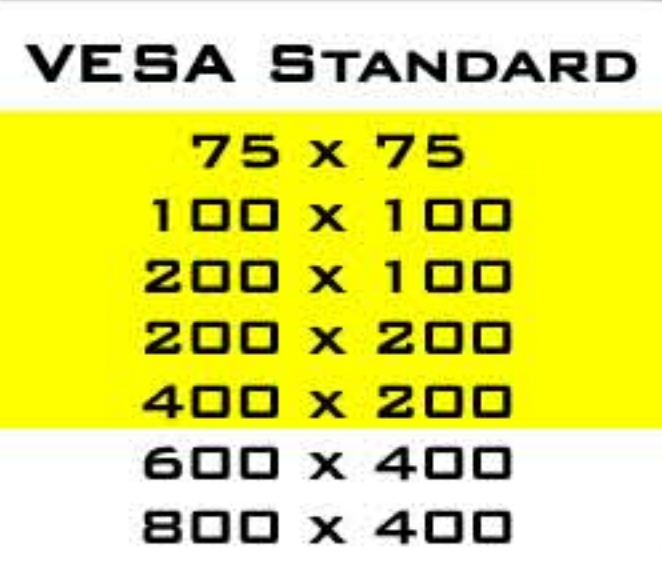
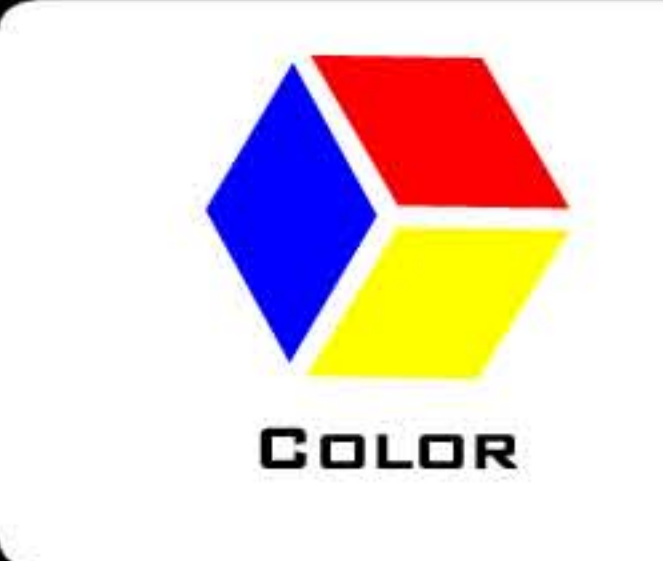
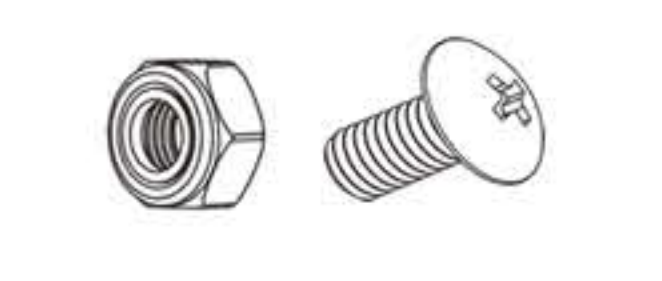
### SPECIFICATIONS

 LOAD	 TILT
50KG (110LBS)	-9 TO +15 DEGREE
 PAN	 SIZE
N.A	26" TO 42"
 DISTANCE FROM WALL	 VERTICAL ADJUSTMENT
64MM(2.52")	AVAILABLE
 HORIZONTAL ADJUSTMENT	 ROTATE
AVAILABLE	N.A
 VESA STANDARD	 COLOR
75 x 75 100 x 100 200 x 100 200 x 200 400 x 200 600 x 400 800 x 400	BLACK
HIGH-LIGHTED	
 HARDWARE	 CABLE MANAGEMENT
INCLUDED	N.A

For General Information & Sales Enquires

OPTVIO PTE LTD

Block 20, Woodlands Link #08 - 11  
Woodlands East Industrial Estate  
Singapore 738733

Website: [www.optvio.com](http://www.optvio.com)  
Tel : (65) 62572029  
Fax : (65) 62575829



PRODUCT OF SINGAPORE