

FLAT PANEL TILT MOUNT LARGE (OPT-WM-35T)

SPECIFICATIONS

- Compatibility : 37" to 63" Flat Panel
- Maximum load : 100 KG (220 lbs)
- Mounting Profile : 68mm (2.68") from wall
- Tilting Angle : -9 to +15 degree
- Color : Black
- Qty / Carton : 4 pcs



KEY FEATURES

- Tilting Range from -9 to +15 degree
- Slim Tilt Mount with only 68mm (2.68") between screen and wall
- Great flexibility and adaptability
- Pre-assembled for ease of installation
- Designed to be mounted on concrete or masonry wall
- VESA compliance
- Hardware included
- Comes with Bubble leveler

DRAWINGS & DIMENSIONS

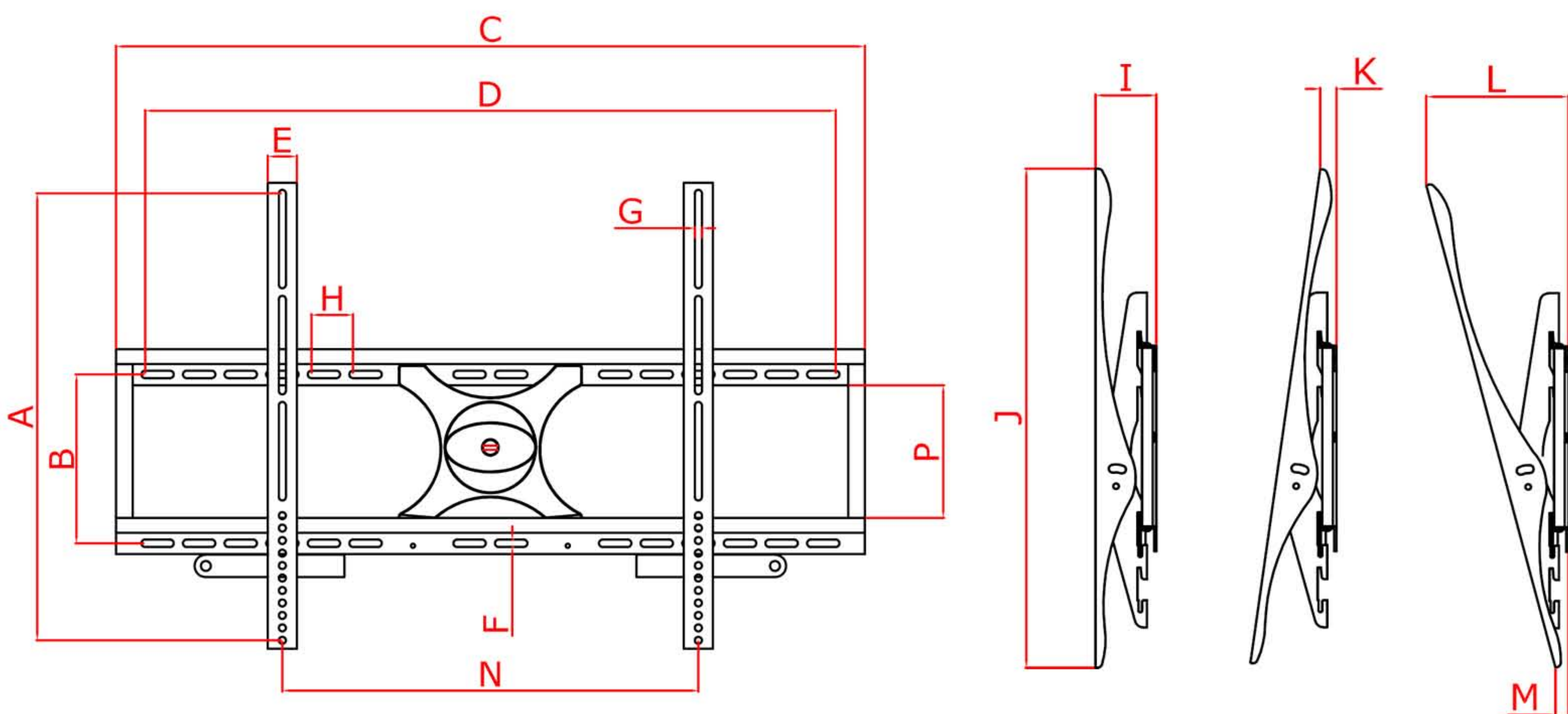





Dimensions

A	21.16"	537.46mm	I	2.68"	68mm
B	7.99"	203mm	J	22.05"	560mm
C	35.43"	900mm	K	0.72"	18.29mm
D	32.87"	835mm	L	6.28"	159.50mm
E	1.38"	35mm	M	0.57"	14.5mm
F	0.43"	11mm	N	10-32.48"	254-825mm
G	0.33"	8.5mm	P	6.28"	159.5mm
H	1.97"	50mm			

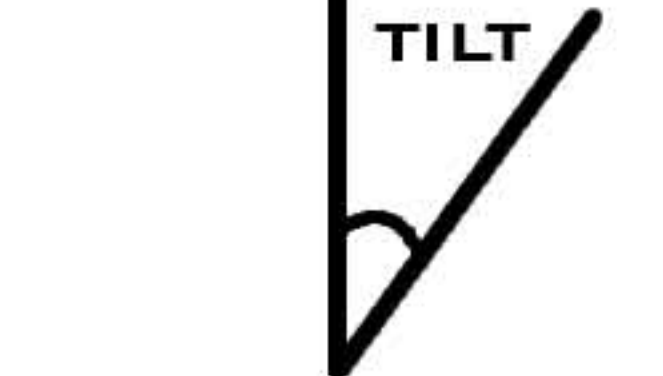
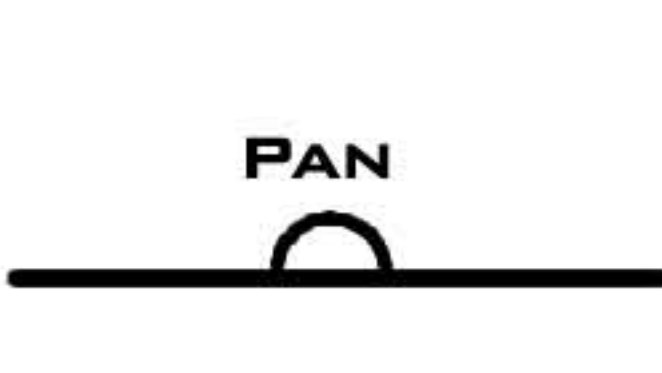
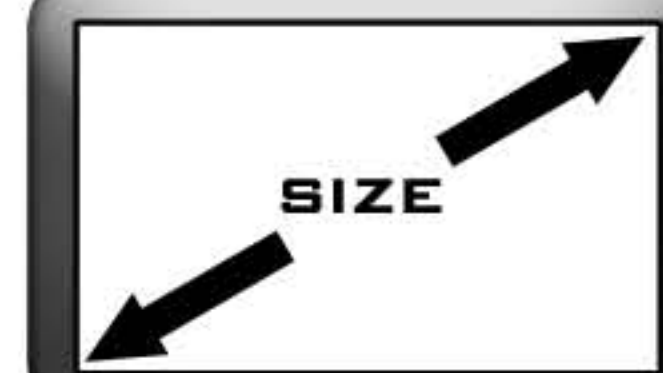
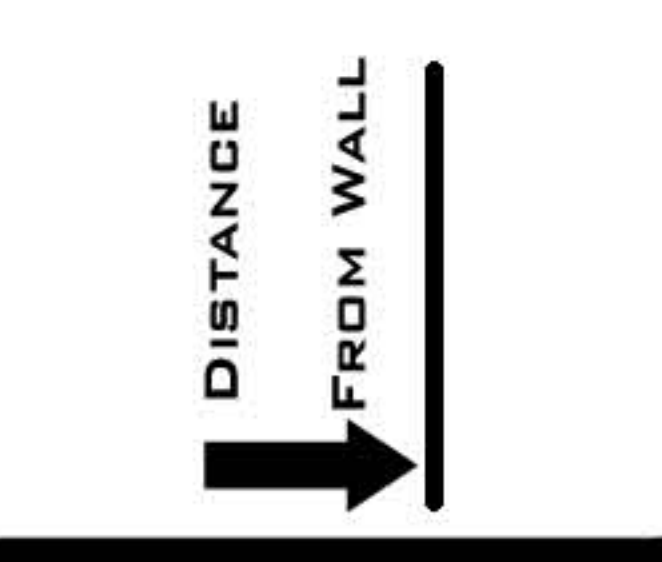
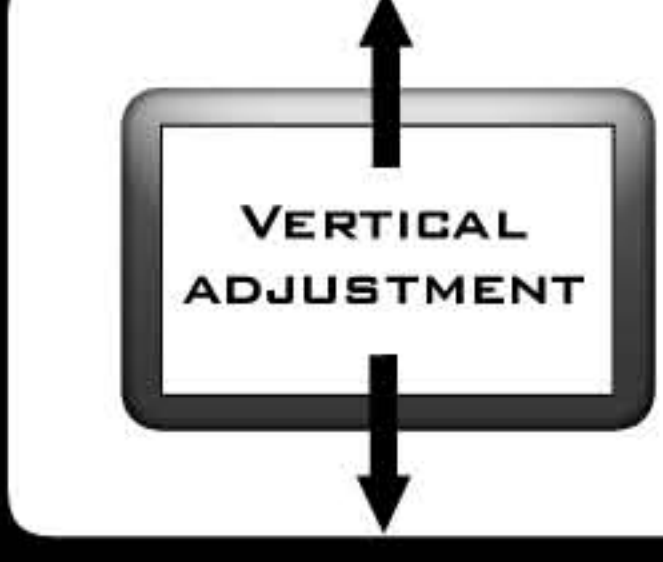
(OPT-WM-35T)

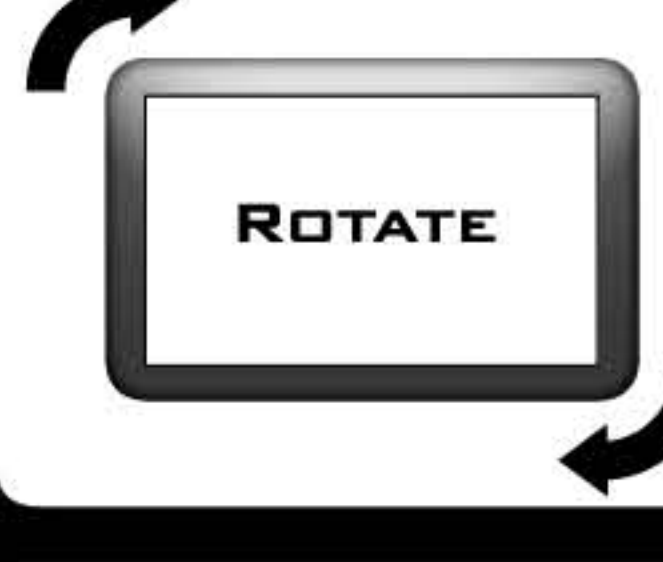
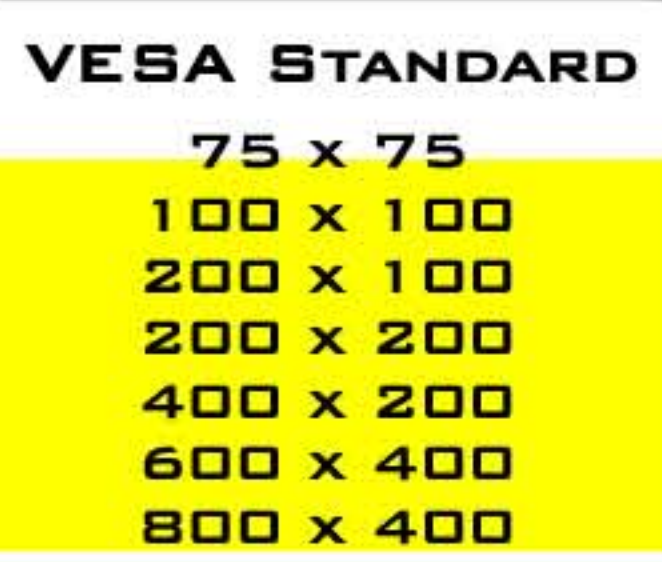
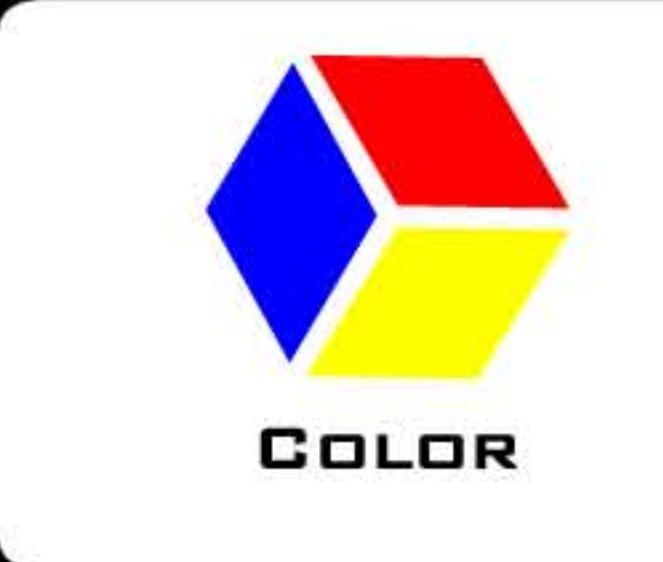
SPECIFICATIONS

 LOAD	 TILT
100KG (220LBS)	-9 TO +15 DEGREE
 PAN	 SIZE
N.A	37" TO 63"
 DISTANCE FROM WALL	 VERTICAL ADJUSTMENT
68MM(2.68")	AVAILABLE
 HORIZONTAL ADJUSTMENT	 ROTATE
AVAILABLE	N.A
 VESA STANDARD 75 x 75 100 x 100 200 x 100 200 x 200 400 x 200 600 x 400 800 x 400	 COLOR
HIGH-LIGHTED	BLACK
 HARDWARE	 CABLE MANAGEMENT
INCLUDED	N.A

For General Information & Sales Enquires

OPTVIO PTE LTD

Block 20, Woodlands Link #08 - 11
Woodlands East Industrial Estate
Singapore 738733

Website: www.optvio.com
Tel : (65) 62572029
Fax : (65) 62575829



PRODUCT OF SINGAPORE